



NeoMetrix
Technologies, Inc.



Creaform Ebook Series
Ebook #1

AN INTRODUCTION TO 3D SCANNING

Fast, furious and disruptive.

While the mainstream media continues its obsession with 3D printing, another quiet, perhaps more impactful, disruption is revolutionizing the way products are designed, engineered, manufactured, inspected and archived. It's 3D scanning -- the act of capturing data from objects in the real world and bringing them into the digital pipeline.

ACCORDING TO A RECENT STUDY
BY MARKETSANDMARKETS, THE
3D SCANNING MARKET WILL GROW
NEARLY

15%

ANNUALLY OVER THE NEXT FIVE
YEARS, WITH THE
PORTABLE 3D SCANNING SEGMENT
LEADING THE WAY.

Portable 3D scanning is fueling the movement from the laboratory to the front lines of the factory and field, driven by the following key factors:

- Convenience and flexibility for a wide variety of applications, including every aspect of product lifecycle management (PLM)
- Simplicity and automation that spreads use beyond specialists into mainstream engineering
- Lower costs that broaden the market
- Greater accuracy, speed and reliability for mission-critical projects.

Bridging physical and digital worlds

3D scanners are tri-dimensional measurement devices used to capture real-world objects or environments so that they can be remodeled or analyzed in the digital world. The latest generation of 3D scanners do not require contact with the physical object being captured.

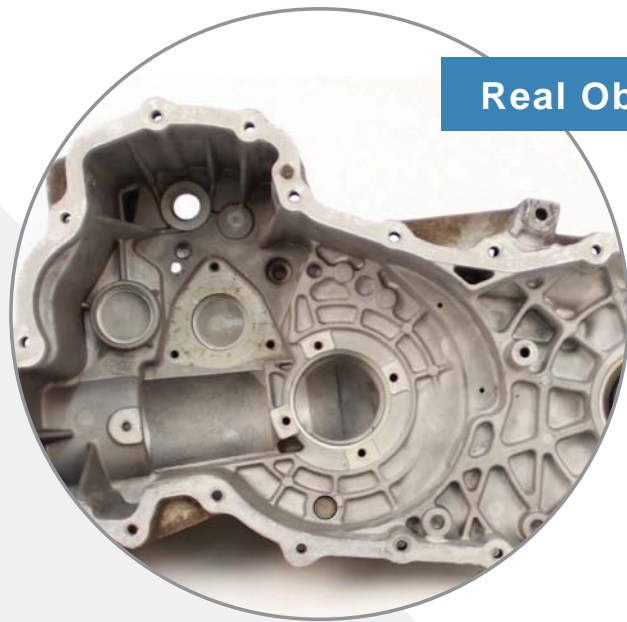

Real Object

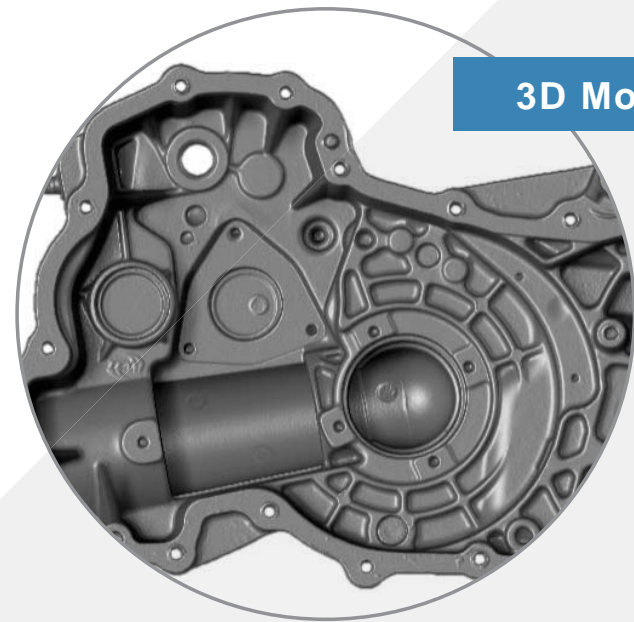

3D Model

3D scanners can be used to get complete or partial 3D measurements of any physical object. The majority of these devices generate points or measures of extremely high density when compared to traditional “point-by-point” measurement devices.

OBJECTS ARE USUALLY
SCANNED IN 3D FOR

2 PURPOSES:

- Extracting dimensions to reconstruct a **CAD** reference file for **reverse engineering** or **rapid prototyping**.
- Measuring the object itself for analysis and documentation. This is done for applications such as **computer-aided inspection (CAI)**, **digital archiving** and **computer-aided engineering (CAE)** analysis.

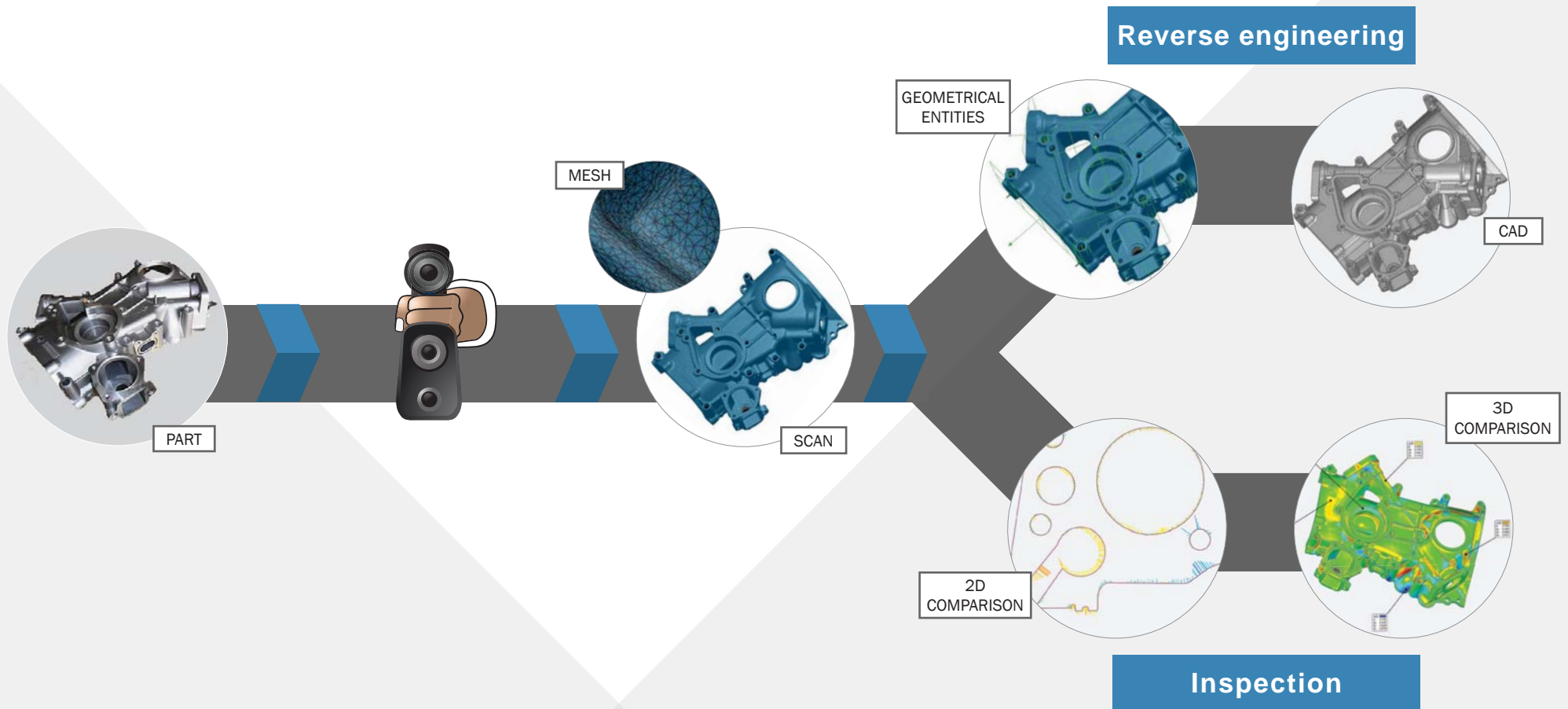

How 3D scanning works

There are TWO major categories of scanners based on the way they capture data:

- **WHITE-LIGHT AND STRUCTURED-LIGHT SYSTEMS**



Take single snapshots or scans

- **SCAN ARMS AND PORTABLE HANDHELD SCANNERS**

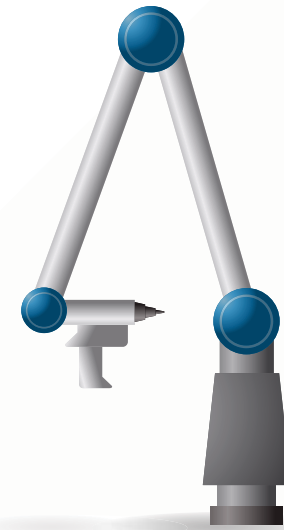

Capture multiple images continuously

How 3D scanning works

Scanning results are represented using free-form, unstructured three-dimensional data, usually in the form of a **point cloud** or a **triangle mesh**. Certain types of scanners also acquire color information for applications where this is important.

Images/scans are brought into a common reference system, where data is merged into a complete model. This process – called **alignment** or **registration** – can be performed during the scan itself or as a post-processing step.

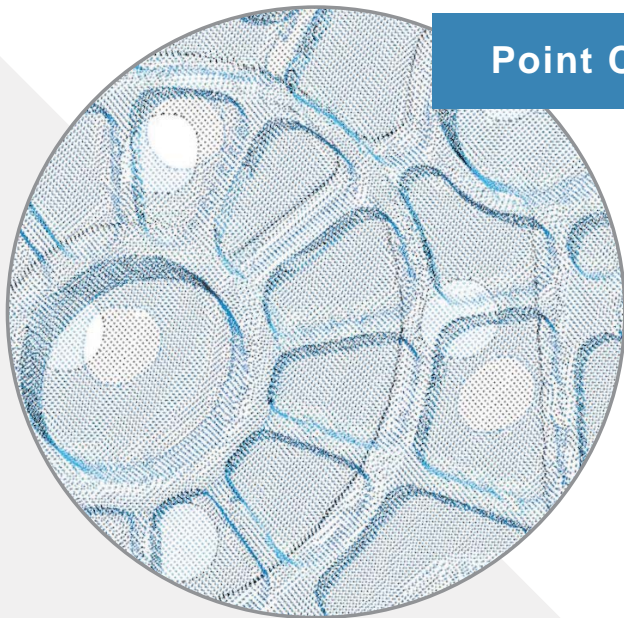

Point Cloud



Triangle mesh

How 3D scanning works

Computer software can be used to clean up the scan data, filling holes, correcting errors and improving data quality. The resulting triangle mesh is typically exported as an **STL** (STereoLithography or Standard Tessellation Language) file or converted to Non-Uniform Rational B-Spline (**NURBS**) surfaces for CAD modeling.



**Triangle Mesh exportable
in STL format**

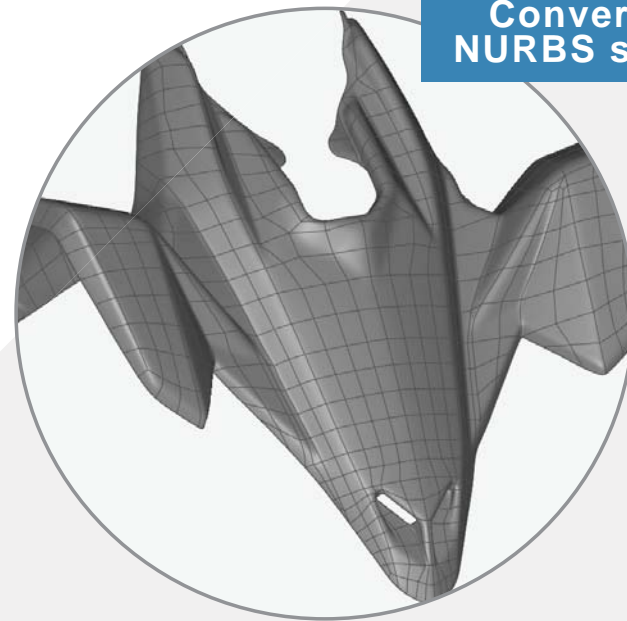

**Converted to
NURBS surfaces**

3D scanning categories and positioning methods

THE BENEFITS AND LIMITATIONS OF A 3D SCANNER ARE TYPICALLY DERIVED FROM ITS POSITIONING METHOD. THAT'S WHY IT IS VALUABLE TO TAKE A LOOK AT POSITIONING METHODS WITHIN THE DIFFERENT 3D SCANNER CATEGORIES.

The main 3D scanner categories:

- Measuring arms, portable CMM scanners
- Tracked 3D scanners
- Structured-light 3D scanners
- Portable 3D scanners



Measuring arms, portable CMM scanners

CMMs (coordinate measuring machines) and measuring arms can be equipped with either fixed-probe or touch-trigger probe heads. It is also possible to mount a 3D scanning head on a CMM.

POSITIONING METHOD: MECHANICAL ENCODERS

CMMs with portable arms are positioned using the mechanical encoders integrated in the arm.

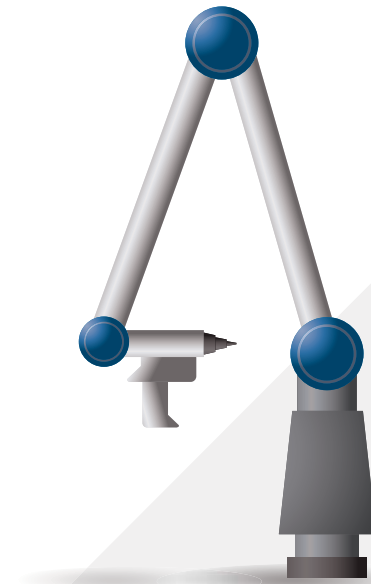

Advantages

Many different tools can be mounted on portable CMMs, making it possible to easily integrate scanning and probing in the same project.

Limitations

Portable CMMs need to be fixed on a surface and use a physical link (arm) as their positioning method. This makes them prone to vibrations and other environmental constraints that can affect the performance and quality of the result. They also lack flexibility in terms of the locations in which they can be used and the shape of the objects they can scan.

Tracked 3D scanners

Optical tracking devices can track various types of measurement tools, including the positioning of a 3D scanner.

POSITIONING METHOD: EXTERNAL OPTICAL TRACKING DEVICE

These scanners use an external optical tracking device to establish positioning. They usually use markers (such as passive or active targets) that optically bind the tracking device to the scanner.

Advantages

Tracked 3D scanners provide very good accuracy and excellent precision throughout the measurement volume. Removing the need for a physical link between the scanner and the object being scanned provides freedom of movement.

Limitations

The optical link that is a strength of this technology is also one of its limitations. The tracker must always have a clear and direct line of sight to the 3D scanner. Trackers often have a limited working volume. Extending the scanning parameters adds complexity to the process and can induce some additional uncertainty in the measurements. Finally, tracked 3D scanners are usually more expensive than solutions such as portable 3D scanners.



Structured-light 3D scanners

These scanners project a pattern of light onto a part and process how the pattern is distorted when light hits the object. Either an LCD projector or a scanned or diffracted laser beam projects the light pattern. One or two (sometimes more) sensors record the projected pattern.

POSITIONING METHOD: OFFLINE TARGET POSITIONING AND GEOMETRY POSITIONING

The scanner can either rely solely on the part geometry to position the data or rely on positioning targets (small stickers provided with the system that can be placed directly on the part) to align 3D data.

If only one camera is used, the position of the projector in relation to the camera must be determined in advance; if two cameras are used, the stereoscopic pair must be calibrated in advance.

Advantages

High-end structured light scanners generate very high-quality data. They typically deliver excellent **resolution**, which allows for the smallest features on an object to be captured in the results.

Limitations

While white-light scanners can acquire large quantities of data in one scan, overall project speed is not always improved by this methodology. Multiple scans are required in most cases to cover all angles on more complex parts, which is very time consuming.



Portable 3D scanners

Many types of portable 3D scanners are available on the market today, principally using laser-line or white-light technologies.

Laser scanners project one or many laser lines on an object while white-light devices project a light and shade pattern. Both will analyze the resulting deformed projections to extract the 3D data.

POSITIONING METHOD: REAL-TIME SELF-POSITIONING THROUGH POSITIONING TARGETS, OBJECT'S NATURAL FEATURES/TEXTURES OR HYBRID

Handheld scanners rely on two cameras to create what is called stereoscopic vision. This enables the device to determine the scanner position in relation to specific points, which could be positioning targets, the object's natural features or textures. Some newer portable scanners use a mix of positioning types called hybrid positioning.



Advantages

Portable 3D scanners can be transported with minimum effort and are often easier to use than other scanner types. They can combine multiple positioning methods, providing the accuracy of positioning targets with the flexibility of object features and texture positioning. The most advanced technologies can acquire more than half a million points per second and rebuild the 3D triangle mesh live during the scanning process.

Limitations

Portable scanners use self-positioning on a more local area, which means that errors can stack up as the scanning volume grows. It is possible to circumvent this by using technologies such as **photogrammetry** and positioning targets to minimize errors, but these additional steps might increase setup time and limit the size of the objects or areas that can be scanned efficiently.

Speeding and enriching the PLM process

3D scanning has emerged as a critical tool in every step of the product lifecycle management (PLM) process. This is especially true of the new generation of truly portable, self-positioning scanners.

The ability of 3D scanning to bridge the gap between physical objects in the real world and the digital design environment has become extremely valuable in a wide range of industries that use PLM -- aerospace, automotive, consumer products, manufacturing, and heavy industries among the principal ones.

These industries benefit from faster time to market, improved quality, reduced warehousing costs, and better understanding of product performance.

In the pages that follow, we'll explore the benefits of 3D scanning in four different stages of PLM:

- **Concept**
- **Design**
- **Manufacturing**
- **Servicing**



3D scanning in PLM: concept

3D scanning is used in the concept stage of PLM for a wide variety of processes, including determining requirements and specifications, concept design (including reverse engineering) and concept prototyping.

Concept

Requirements and specifications >



- Competitive product analysis
- Measurement of product environment or connecting/Surrounding parts
- Measurement of existing parts for aftermarket or custom equipment

Concept design >



- Clay model measurement/Reverse engineering
- Models and mock-ups measurement/Reverse engineering
- Styling and aesthetics

Concept prototyping



- Integration of prototype modifications into CAD file
- Form study, proof-of-concept prototypes
- Ergonomy prototypes

Spotlight on applications

Jump-starting the conceptual process



Midwestern Manufacturing produces sideboom pipelayer attachments for new and old tractors from industry leaders such as Caterpillar, John Deere, Case and Komatsu. When 3D models are not available, Midwestern uses reverse engineering to capture a tractor and create a fully integrated sideboom.

The ability to quickly create a detailed, accurate model of the tractor jump-starts the design process and enables Midwestern to reduce product development time.

“ The detailed 3D scans and 3D model allow us to accurately design and integrate our sideboom attachment onto the existing platform (tractor),”

says the vice president of engineering for Midwestern.

“ The fact that the (scan) files are so accurate considerably minimizes the amount of modifications we have to make to the platform. It also allows us to completely visualize the design before final approval and production.”

3D scanning in PLM: design

3D scanning is used in the design stage of PLM for computer-aided design (CAD); rapid prototyping; and testing, simulation and analysis (CFD, FEA).

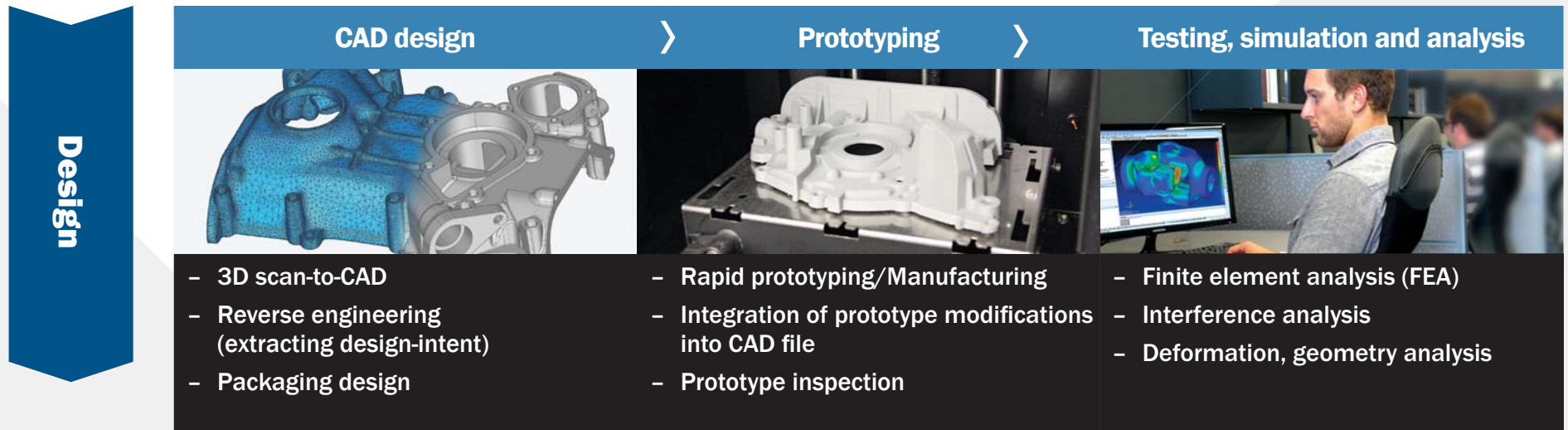

Spotlight on applications

Designing a custom product based on client requirements

Zeel Design is an engineering consulting firm and manufacturer of customized parts and vehicles that specializes in styling, engineering, CAD, FEA, manufacturing, CNC machining, binding and welding.

A motorcycle chassis is very complex and features irregular shapes; as a result, the conventional methods used for designing modified components are long and tedious. Having no access to manufacturers' 3D drawings, a powerful reverse engineering solution was needed to reduce the production times of CAD drawings.

3D scanning makes it possible to easily and rapidly obtain a highly accurate 3D images of the assembly and all of the existing components at the same time—without having to draw them in 3D. The engineering consulting firm managed to reduce by 70-90% the time they previously spent on CAD drawings and the reverse engineering process. The use of a self-positioning hand-held laser scanner right in the shop played a key role in Zeel Design being able to drastically reduce design project turnaround times.

“ Considering how often we use our 3D scanner, and if we add up the work hours that we are saving, we expect to get an excellent ROI very quickly.”

- According to the president of Zeel Design



3D scanning in PLM: manufacturing

3D scanning is used in the manufacturing stage of PLM for applications such as tooling design, assembly and production, and quality control.

Manufacturing

Tooling design	Assembly/Production	Quality control
		
<ul style="list-style-type: none">- Reverse engineering of dies, molds, fixtures, jigs and patterns- Update of CAD file to reflect as-built tooling measurements- Tooling validation/Inspection	<ul style="list-style-type: none">- Virtual assembly- Tool/Robot path programming- Part assessment before machining	<ul style="list-style-type: none">- First article inspection (FAI)- Part-to-CAD inspection- Supplier quality inspection

Spotlight on applications

Measuring tooling and parts for deformation

The European Aeronautic Defense and Space (EADS) company, recently renamed Airbus Group, performs 3D optical scans of tooling equipment to assess the possible geometric distortion of carbon fiber composite (carbon/epoxy) parts as well as post-manufacturing deformation with parts/CAD comparisons.

First, EADS scans the tooling, in order to verify its compliance with the CAD plan. Then, parts manufactured with this tooling are scanned, and the scanning files are compared.

The second step consists of using very powerful simulation tools to estimate the distortion of the parts before manufacturing in order to compare the scan files of the manufacturing parts.

The versatility of a portable 3D scanner made it the tool of choice for this task, both in its capacity to scan unorthodox shapes, handle hard-to-scan materials, such as composite parts, and perform scans directly on the project's site.

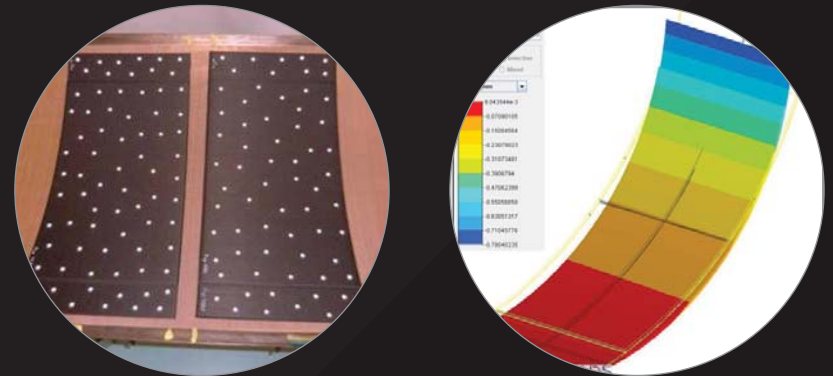

“ Thanks to its quick set up and acquisition, ease of use, measurement performance for many types of surface states, and portability, the system enabled us to quickly scan the metallic tooling and carbon fiber composite parts. The equipment’s portability made it possible for us to record the measurements right at the manufacturing site.”

A member of the EADS Structure Health Engineering (NDT & SHM) Department

Spotlight on applications

Matching mold to CAD during manufacturing

When it comes to manufacturing using molds and dies, what you get is not always what you created in the CAD file.

Stamping, casting and plastic injection are all susceptible to phenomena such as shrinkage and spring-back, which is the difference in shape between the actual contours of dies and the shape of the stamping produced in them. As a result, it is complicated to match the actual die or mold to the CAD geometry.

That's where portable 3D scanning comes in: 3D scan data provides insights into deviations that might occur during mold and die production. The ability to accurately monitor die and mold geometry and the corresponding parts it produces helps reduce design iterations, saving time and resulting in parts that more accurately match the CAD reference.



3D scanning in PLM: servicing

3D scanning is used in the servicing stage of PLM for applications such as documentation; maintenance, repair and overhaul (MRO); and replacement, recycling and restoration of parts.

Servicing

Documentation



- As-built documentation of parts/Tooling
- Marketing presentations, 3D training systems, serious gaming
- Digital archiving



Maintenance, repair and overhaul (MRO)

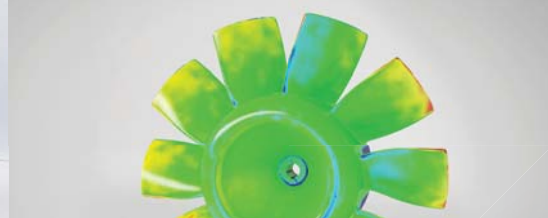

- Wear and tear analysis
- Custom repairs/Modification
- As-built documentation of parts/Tooling before maintenance



Replacement/Recycling



- Reverse engineering for developing replacement/Restoration parts
- Planning of complex assemblies disassembly/Dismantling

Spotlight on applications

Real-time feedback from the field

Atlas Weyhausen, a manufacturer of wheel loaders and other heavy equipment, uses a portable 3D scanner to measure components and equipment for quality assurance and for data feedback from prototype parts. The company saves time and money from the increasing number of situations where components must be inspected at their installed location or recorded abroad at the supplier's location.

Having digital files for a component is a major benefit. The steel construction of a new driver's cab and various paneling sections have been digitized, for example, and the resulting CAD files are available at any time for quality comparisons.

“ The major benefit of the scanner is easy to see, ”

says an Atlas quality assurance manager.

“ Freeform surfaces are easy to align, along with 3D data. A further benefit is the data feedback into our CAD system. ”

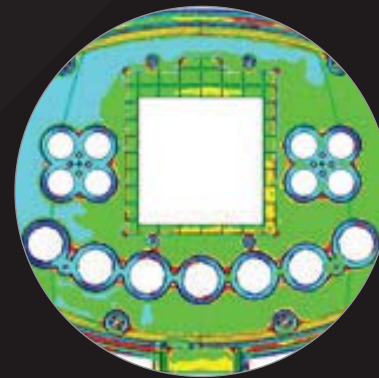
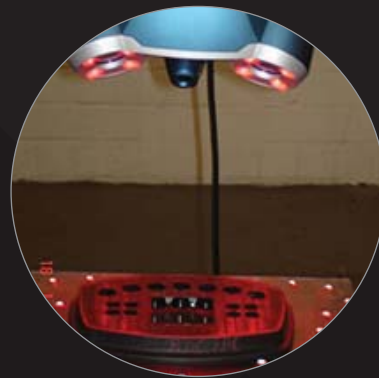

3D scanning beyond PLM

3D scanning is used in **digital reconstruction** to capture an actual object or environment – such as an historical artifact or a legacy product – and reproduce it as accurately as possible for digital archiving, re-creation or preservation.

3D scanning is used in **customized manufacturing** to enable nearly infinite variations on basic designs of existing consumer products, including toys, accessories and apparel.

Customization extends to capturing the human body for individualized medical devices and for fit-to-body design.

A full range of applications can be found in the [Creaform website](#).

- Oil and Gas
- Health Care
- Education and Research
- Computer graphics/special effects
- Digital preservation
- Arts and architecture
- Virtual reality



Spotlight on applications

Bringing new life to a 19th-century art form

Milwaukee School of Engineering's (MSOE) Rapid Prototyping (RP) Center modeled a time capsule from 3D scan data of an actual 19th-century Edgefield face jug. The time capsule was a central part of Face Jugs: Art and Ritual in 19th-Century South Carolina, an exhibition that originated at the Milwaukee Museum of Art.

The original face jug -- about the size of a grapefruit -- would normally be covered in a powder to reduce the reflectivity of the ceramic finish, but that could not be done with a fragile, valuable piece.

MSOE covered the face jug with a fine black net containing target dots that served as reference points for the 3D scanner. Geomagic software was used to upsize the scan model and create the compartments and other features of the time capsule.

The final product was 3D printed and finished with electroplating.



A fast-developing discipline with a bright future

This e-book provided you with a high-level overview of 3D scanning and a glimpse into the multitude of new possibilities and applications it enables in a variety of disciplines.

Most of the key developments in 3D scanning have come about in less than a decade. Indeed, 3D scanning is a fast-growing discipline with tremendous potential in the future.

To explore a broader range of 3D scanning topics, we invite you to visit the applications section on www.creaform3d.com

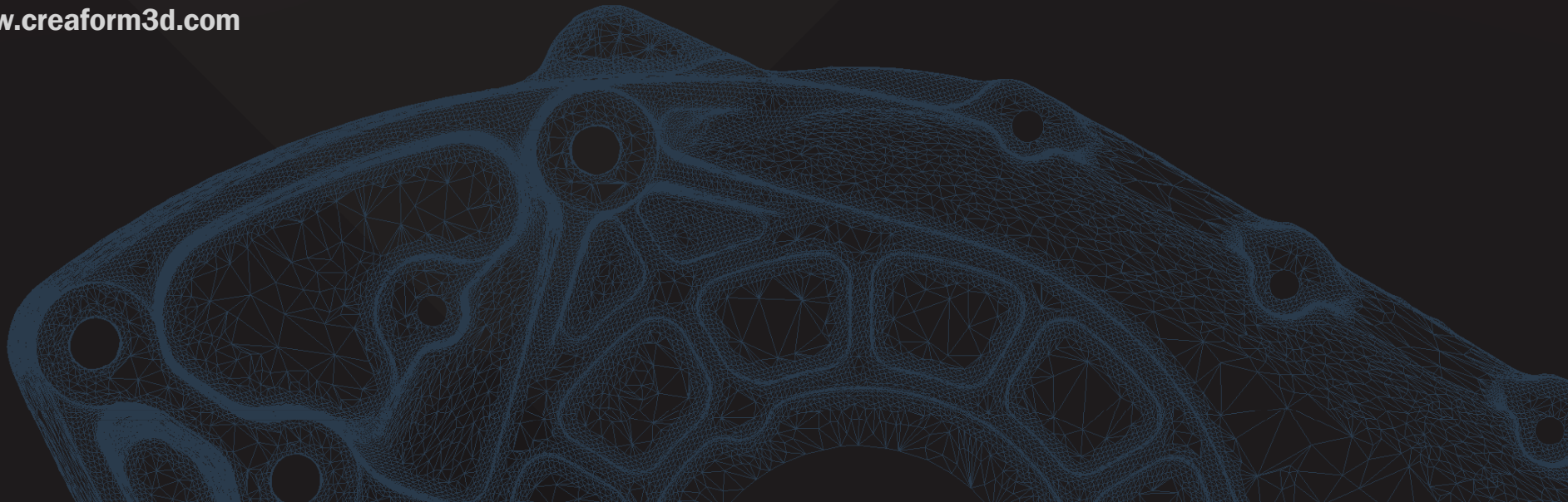

Glossary of 3D scanning terms

- **3D scanner** -- A device that captures data on the shape and colors of a real-world environment for processing in the digital world, such as construction of 3D models.
- **Accuracy** -- The accuracy of a mesh file is measured by the deviation between the actual part and the measured result. It depends on the specifications of the scanner used and on the quality of the set-up. In 3D scanning, accuracy differs from resolution (see below).
- **Alignment** -- In 3D scanning, this refers to the act of bringing all the scans into a common reference system, where data is merged into a complete model. Also called registration.
- **CAD** -- Computer-aided design; the act of creating a digital model for design, engineering and manufacturing. The models are based on various geometric entities such as triangles, lines and curved surfaces. Typical formats for CAD models are .stp and .igs.
- **CAE** -- Computer-aided engineering; the act of digitally simulating performance of objects and assemblies. CAE encompasses simulations such as finite-element analysis (FEA) and computational fluid dynamics (CFD).
- **CFD** -- Computational fluid dynamics; a digital process by which engineers can simulate how fluids such as air, water and gas behave within different design, engineering and natural environments.
- **CMM arm** -- A coordinate measurement machine that uses a point or ball probe on an articulating arm, allowing users to collect individual 3D data points from a physical object.
- **CMM arm encoder** -- An opto-electronic device that detects the incremental lines on a scale to determine positioning. An encoder is also known as a reader head.¹
- **CNC milling** -- Computer numerical control; computer-controlled milling machines that can create products along multiple axes for improved precision.

- **CAI** -- Computer-aided inspection; the use of 3D scanning to compare an as-manufactured part to its CAD equivalent or ideal specifications for quality control, wear-and-tear assessment and other forms of analysis.
- **Customized manufacturing** -- Using 3D scanning and complementary software to enable wide varieties of design choices at a reasonable cost. Sometimes called mass customization. Can also be used to describe the ability to customize medical and sports products -- such as prostheses, athletic shoes and dental implants -- for individual physiologies.
- **Digital archiving** -- The ability to save models of physical objects in a digital environment, saving time and money.
- **Digital reconstruction** -- The act of scanning a physical object in order to rebuild or renovate it close to its original state or at a different scale.
- **Dynamic referencing** -- The ability of a scanner to ensure that the measuring device is continuously locked to the part by an optical link, providing greater accuracy in factory and field environments.
- **FEA** -- Finite-element analysis; a digital process by which engineers can simulate how the structure of an object or assembly performs under different environmental stresses.
- **Normal** -- In 3D space, a surface normal is the vector cross product of two (non-parallel) edges of a polygon.²
- **NURBS** -- Non-uniform rational b-spline; a mathematical model used in computer graphics and CAD to generate curves and surfaces.
- **Optical CMM scanner** -- A 3D scanner tracked by optical CMMs. Optical CMM cameras track passive or active reflectors affixed to the 3D scanner itself and to the part being scanned to dynamically reference them in 3D space.
- **Photogrammetry** -- A methodology for extracting high-accuracy measurements from photos of an object or environment.
- **Product lifecycle management (PLM)** -- The practice of monitoring and managing a product from inception to end of useful life.
- **Point cloud** -- A set of data points within a coordinate system. In a three-dimensional coordinate system, these points are usually defined by XYZ coordinates, and are intended to represent the external surface of an object. Typical formats for point clouds are .txt, .igs and .ascii.

- **Rapid prototyping** -- The process of quickly fabricating a model of a physical part or assembly using 3D STL or CAD data. 3D scanning is often the front end of the process and 3D printing the back end.
- **Reverse engineering** -- The process of discovering the technological aspects of a device, object or system through analysis of its structure, function and operation. In 3D scanning, the reverse-engineering process involves measuring an object and then reconstructing it as a 3D model.
- **Resolution** -- Defines the level of details visible in the scan data and measured in millimeters (mm). It can be compared to a screen resolution, which is defined by the number of pixels. A higher resolution increases the number of triangles in a mesh file.
- **Repeatability** -- The variation in measurements taken by a single person or instrument on the same item under the same conditions.
- **Self-positioning 3D laser scanners** -- Laser scanning systems that use retro-reflective targets as a reference. These scanners do not require external positioning systems because the position of the scanner in relation to the object being scanned is determined by triangulation between the scanner's two cameras and the patterns of the positioning targets. Data acquisition is in real time.
- **Self-positioning 3D white-light scanners** -- The scanner obtains its position relative to the physical object by looking at the distortion of the white-light pattern on the scanned part. These scanners obtain their position on a continuous basis in real time as they move over the part.
- **STL** -- Stands for stereolithography or standard tessellation language; a file format native to stereolithography CAD software created by 3D Systems Inc. and supported by many other software packages. STL files are used widely for rapid prototyping and computer-aided manufacturing.
- **Triangulation** -- The process of determining the location of a point by measuring angles to it from known points at either end of a fixed baseline. The point can then be fixed as the third point of a triangle with one known side and two known angles.
- **Triangle mesh** -- The output of self-positioning 3D scanners, this is a mesh from an optimized surface that takes into account measuring conditions and consistency. This is also referred to as a polygon model. Typical formats are .stl, .obj and .sat. An STL file can be used directly for applications such as rapid prototyping and computer-aided inspection or converted into NURBS surfaces for CAD.

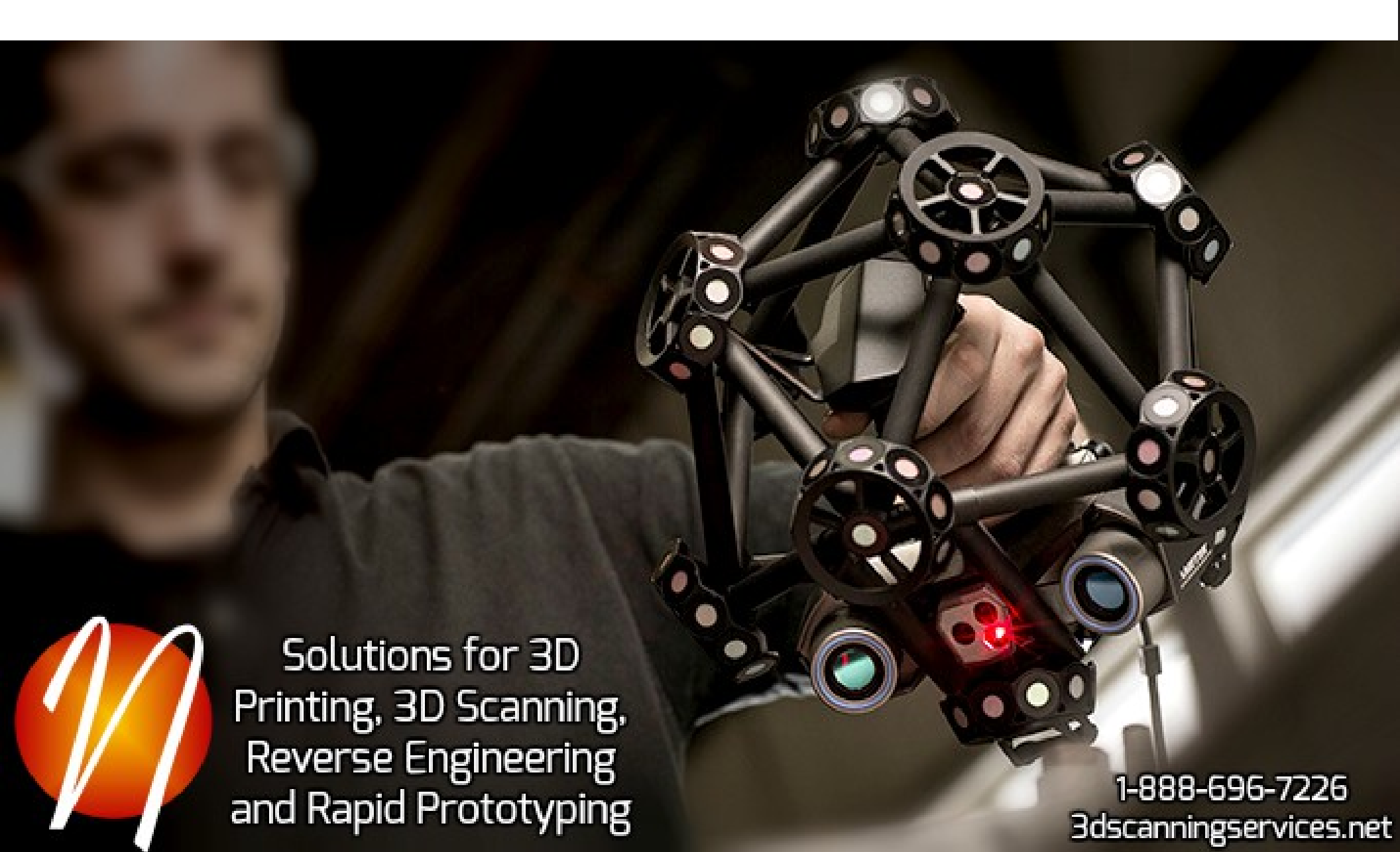

Solutions for 3D
Printing, 3D Scanning,
Reverse Engineering
and Rapid Prototyping

1-888-696-7226
3dscanningservices.net

To Download Part 2 of our
Introduction to 3D Scanning
Whitepaper Series, please contact
us at info@neometrixtech.com